

35 foot wide homes on 50 foot wide lots

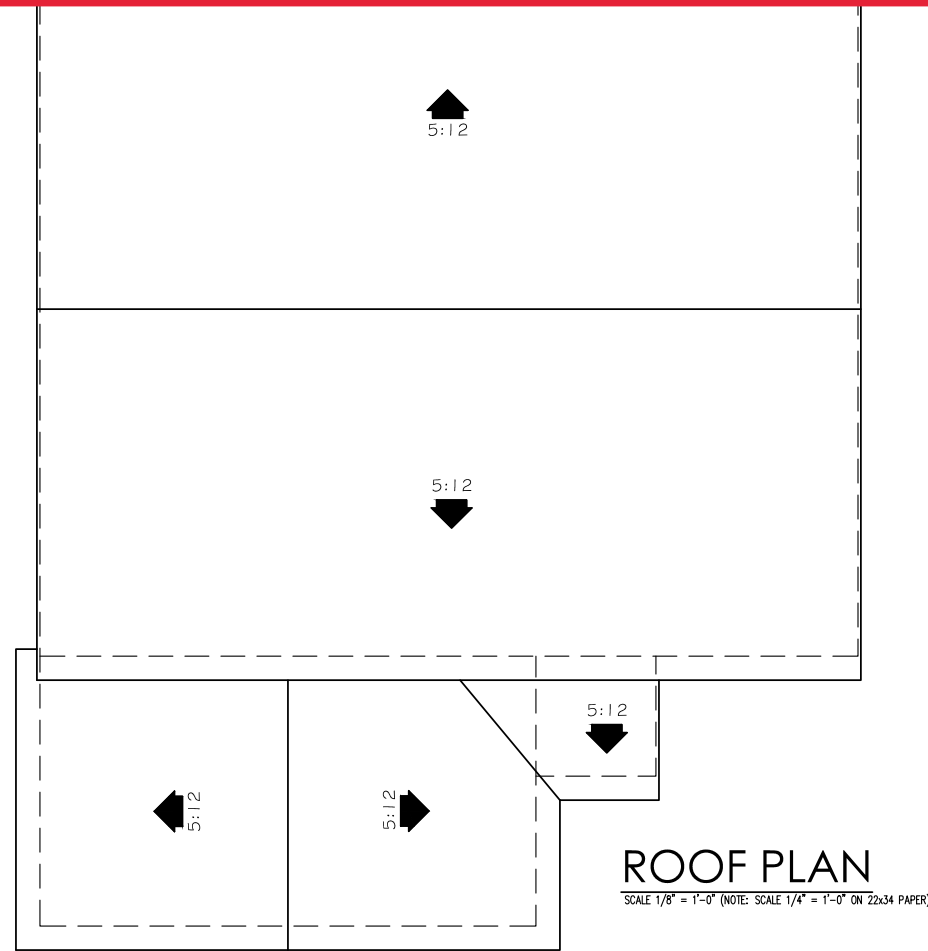

FRONT ELEVATION / 2773 ELEV "B"

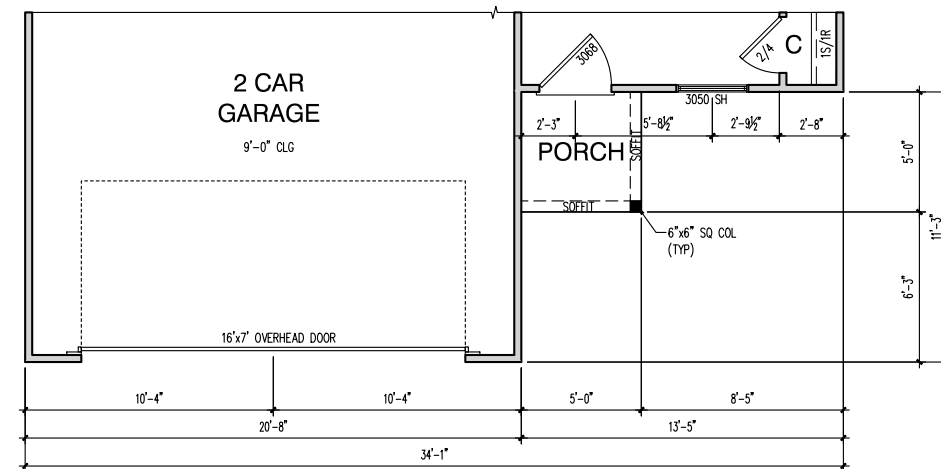
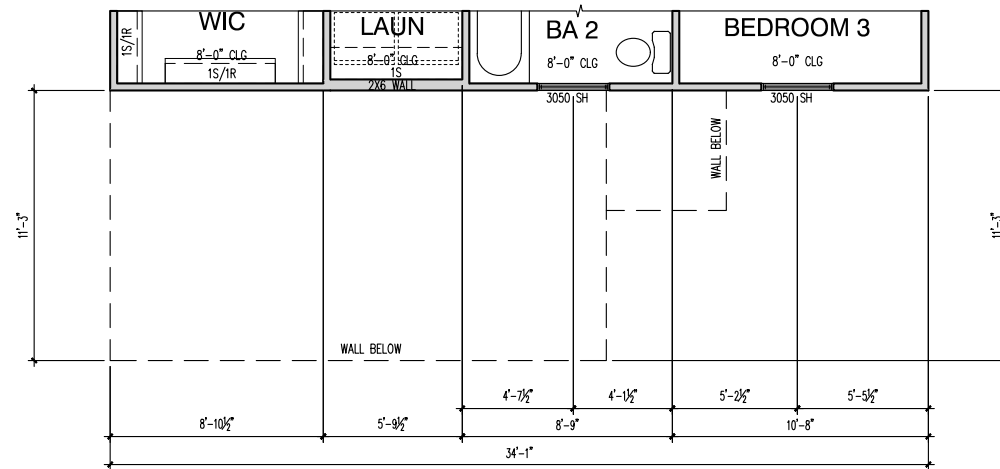

PLOTTED: 8/28/2019 11:59 AM PLOTTED BY: Bertrand Cineas FILE LOCATION: DESIGN-SHEETS.DWG

PLOTTED: 8/29/2019 1:57 PM PLOTTED BY: Bertrand Cineas FILE LOCATION: DESIGN-SHEETS.DWG

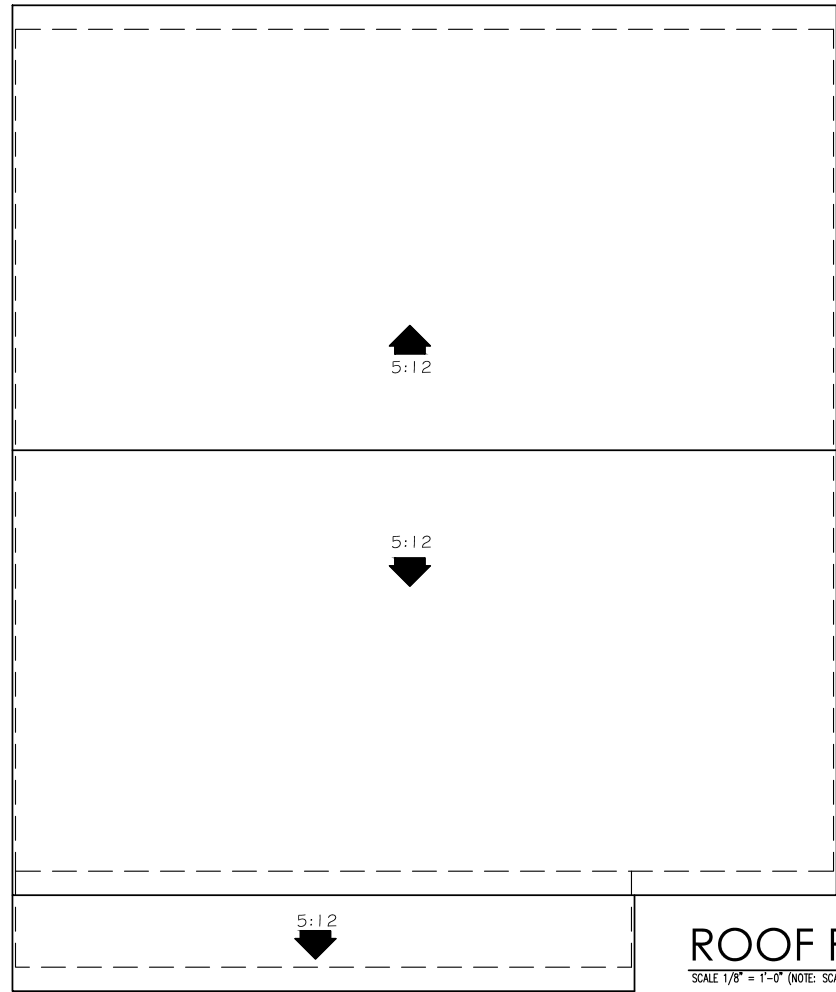

ROOF PLAN

SCALE 1/8" = 1'-0" (NOTE: SCALE 1/4" = 1'-0" ON 22x34 PAPER)



FRONT ELEVATION / 2774 ELEV "B"



FRONT ELEVATION

SCALE 1/8" = 1'-0" (NOTE: SCALE 1/4" = 1'-0" ON 22x34 PAPER)

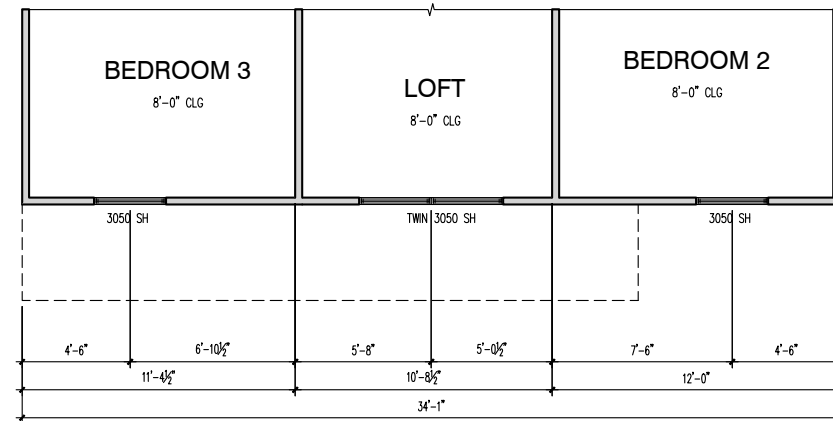

PARTIAL SECOND FLOOR PLAN

SCALE 1/8" = 1'-0" (NOTE: SCALE 1/4" = 1'-0" ON 22x34 PAPER)

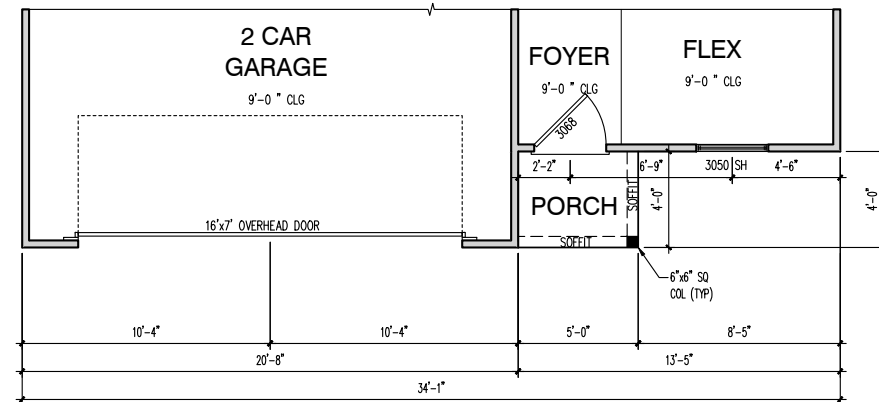

PARTIAL FIRST FLOOR PLAN

SCALE 1/8" = 1'-0" (NOTE: SCALE 1/4" = 1'-0" ON 22x34 PAPER)

2774.000

PROJECT: TCG 4-35'
NPC: 2774
TOTAL COND. SQ.FT.: 2031
DATE: 08/29/2019
DESIGNER: NAS

PLOTTED: 8/29/2019 3:40 PM PLOTTED BY: Bertrand Cineas FILE LOCATION: DESIGN-SHEETS.DWG

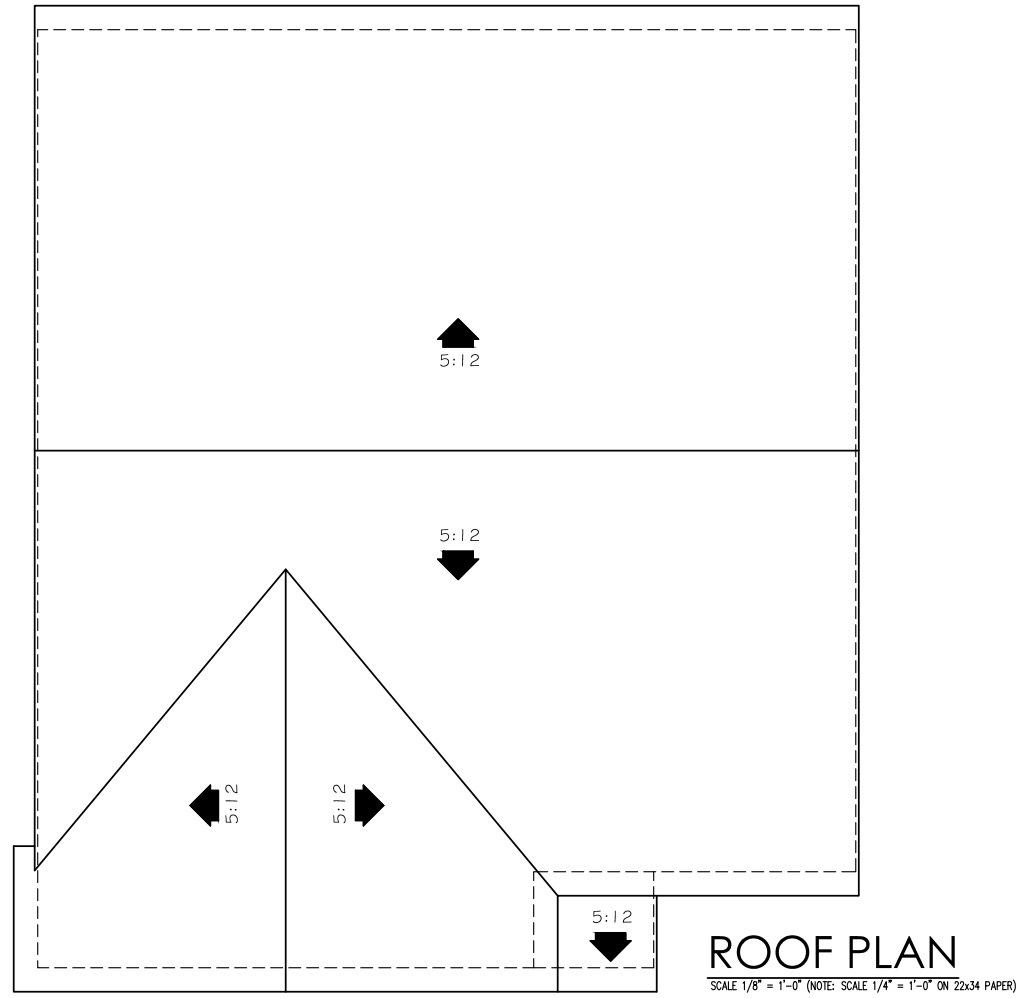

FRONT ELEVATION / 2775 ELEV "B"



FRONT ELEVATION

SCALE 1/8" = 1'-0" (NOTE: SCALE 1/4" = 1'-0" ON 22x34 PAPER)

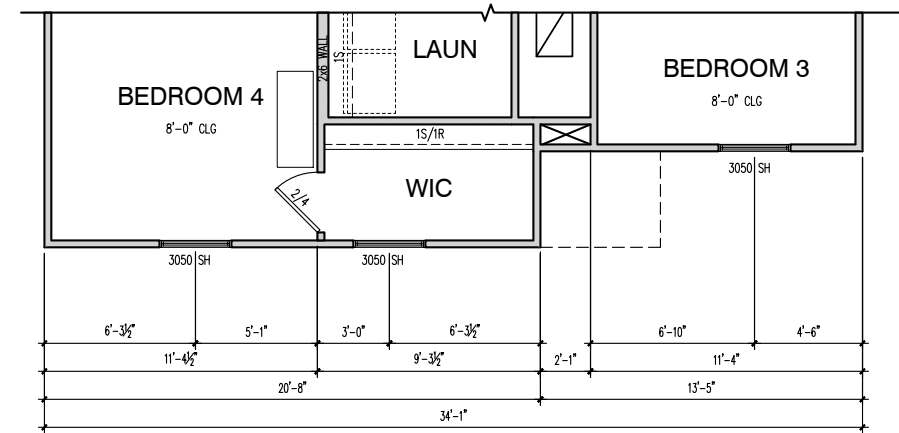

PARTIAL SECOND FLOOR PLAN

SCALE 1/8" = 1'-0" (NOTE: SCALE 1/4" = 1'-0" ON 22x34 PAPER)

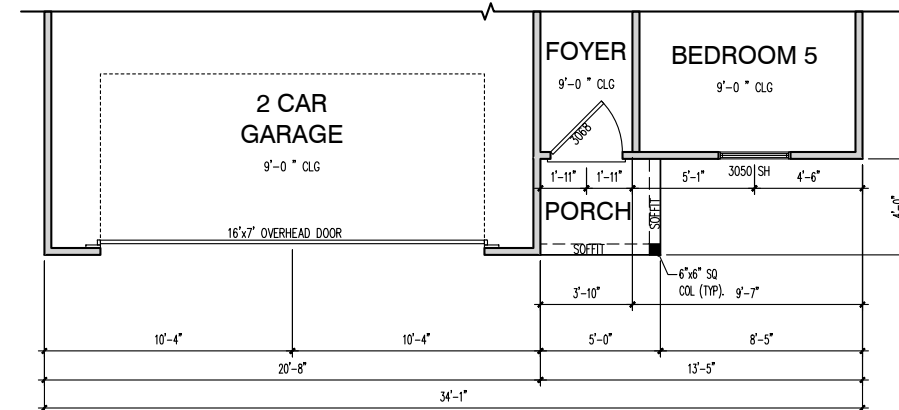

PARTIAL FIRST FLOOR PLAN

SCALE 1/8" = 1'-0" (NOTE: SCALE 1/4" = 1'-0" ON 22x34 PAPER)

2775.000
NAS

PROJECT: TCG 4-35'
NPC: 2775
TOTAL COND. SQ.FT.: 2110
DATE: 08/29/2019
DESIGNER: ---
SHEET: 3 OF

PLOTTED: 8/29/2019 4:16 PM PLOTTED BY: Bertrand Cineas FILE LOCATION: DESIGN-SHEETS.DWG

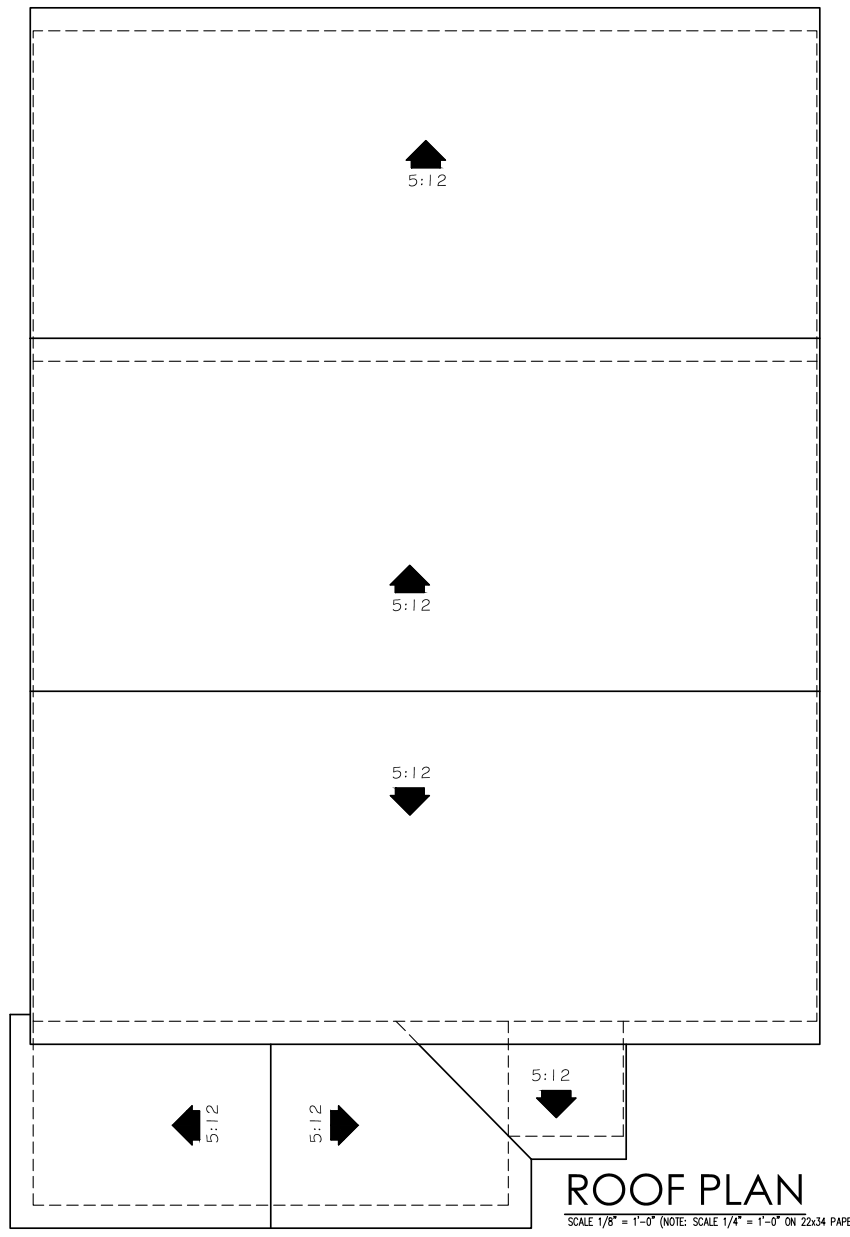

ROOF PLAN
SCALE 1/8" = 1'-0" (NOTE: SCALE 1/4" = 1'-0" ON 22x34 PAPER)



FRONT ELEVATION / 2776 ELEV "B"



FRONT ELEVATION
SCALE 1/8" = 1'-0" (NOTE: SCALE 1/4" = 1'-0" ON 22x34 PAPER)

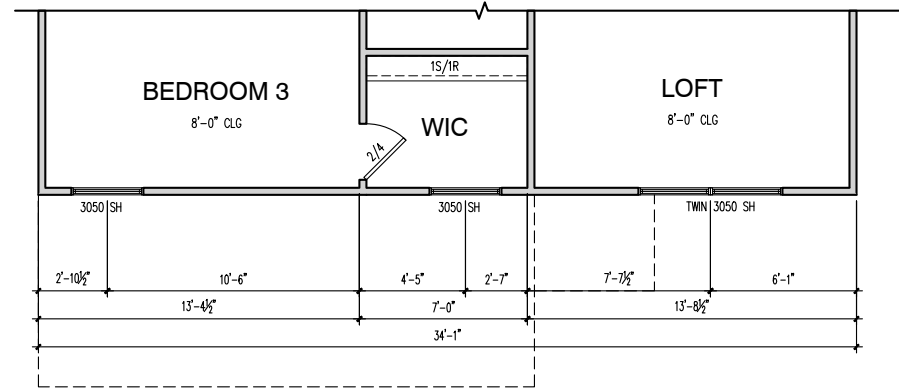

PARTIAL SECOND FLOOR PLAN
SCALE 1/8" = 1'-0" (NOTE: SCALE 1/4" = 1'-0" ON 22x34 PAPER)

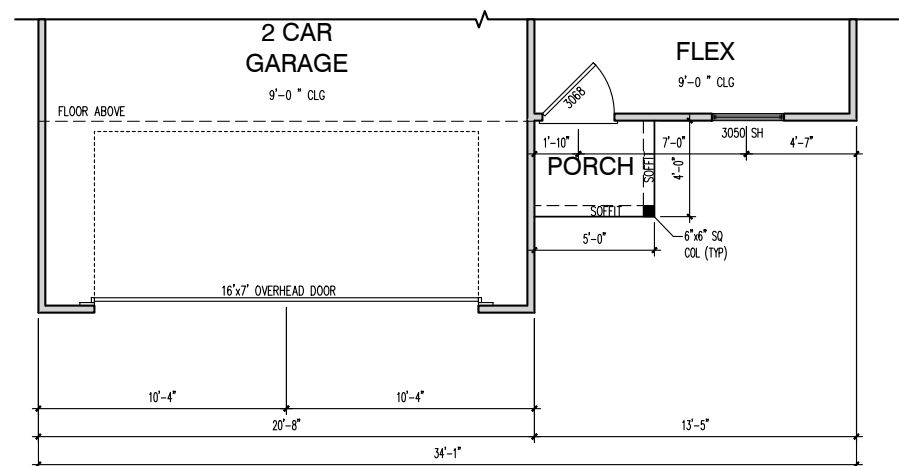

PARTIAL FIRST FLOOR PLAN
SCALE 1/8" = 1'-0" (NOTE: SCALE 1/4" = 1'-0" ON 22x34 PAPER)

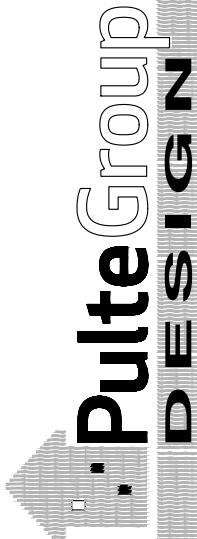

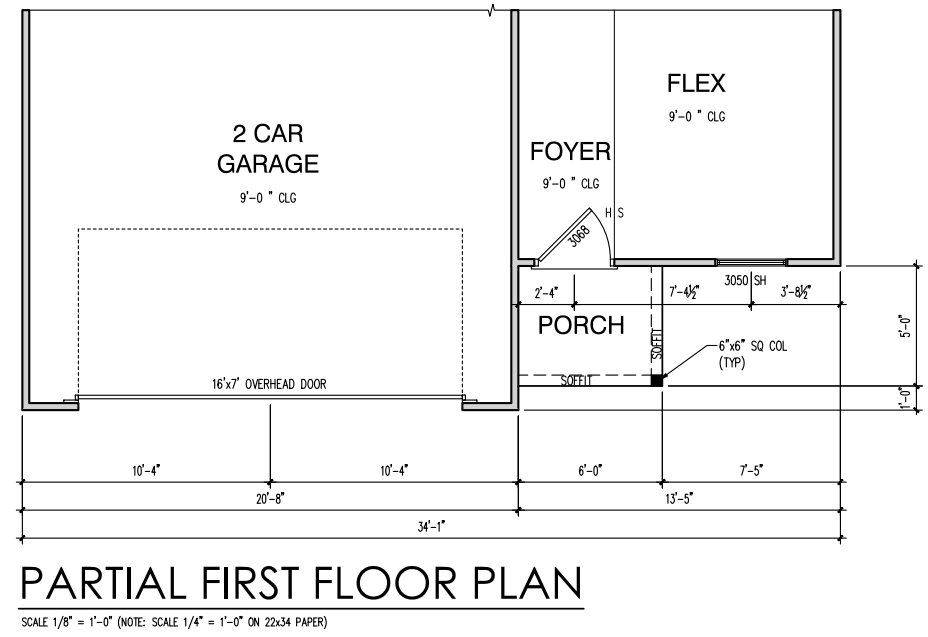
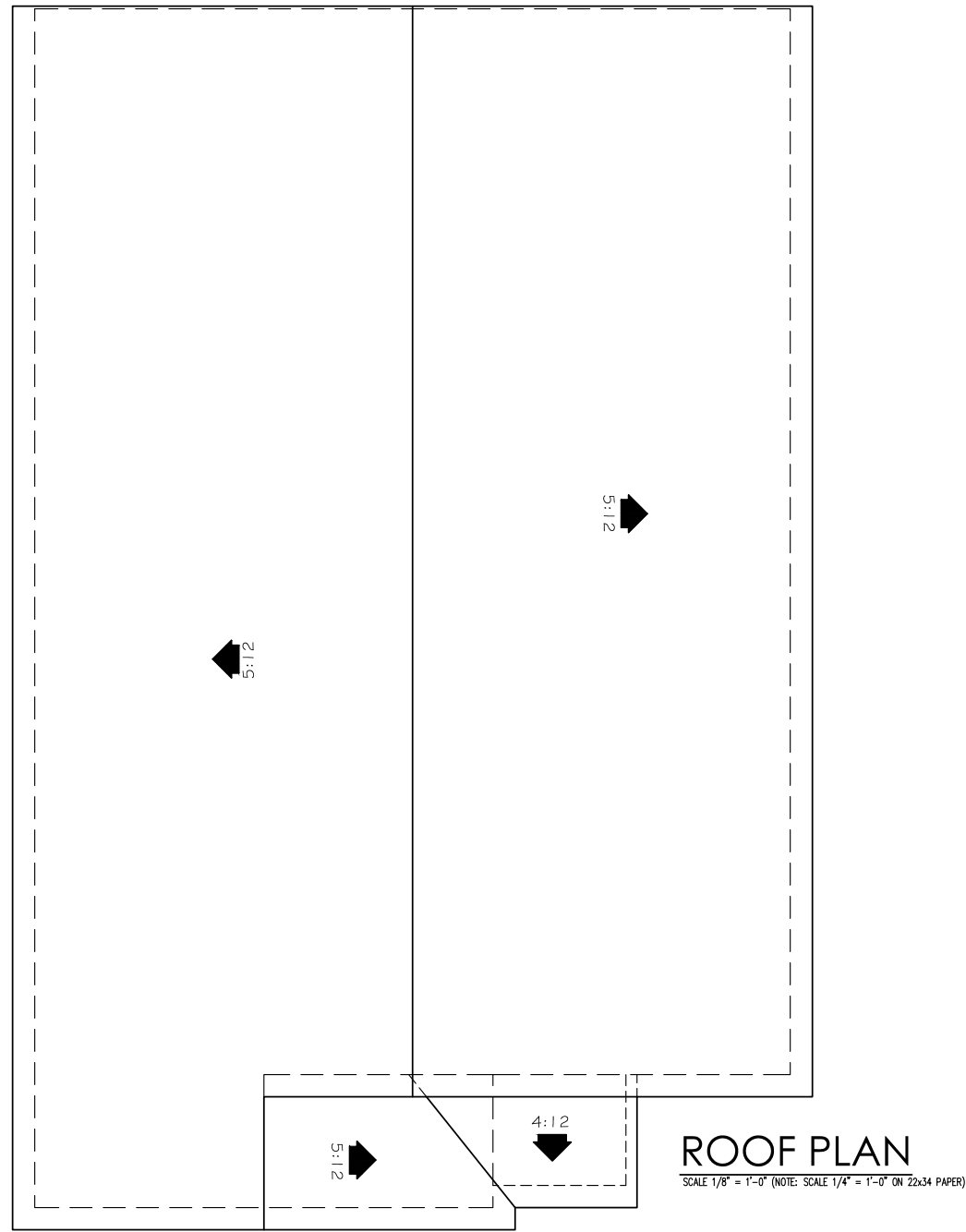

PLOTTED: 5/1/2019 2:36 PM PLOTTED BY: Michael Lee FILE LOCATION: DESIGN-SHEETS.DWG

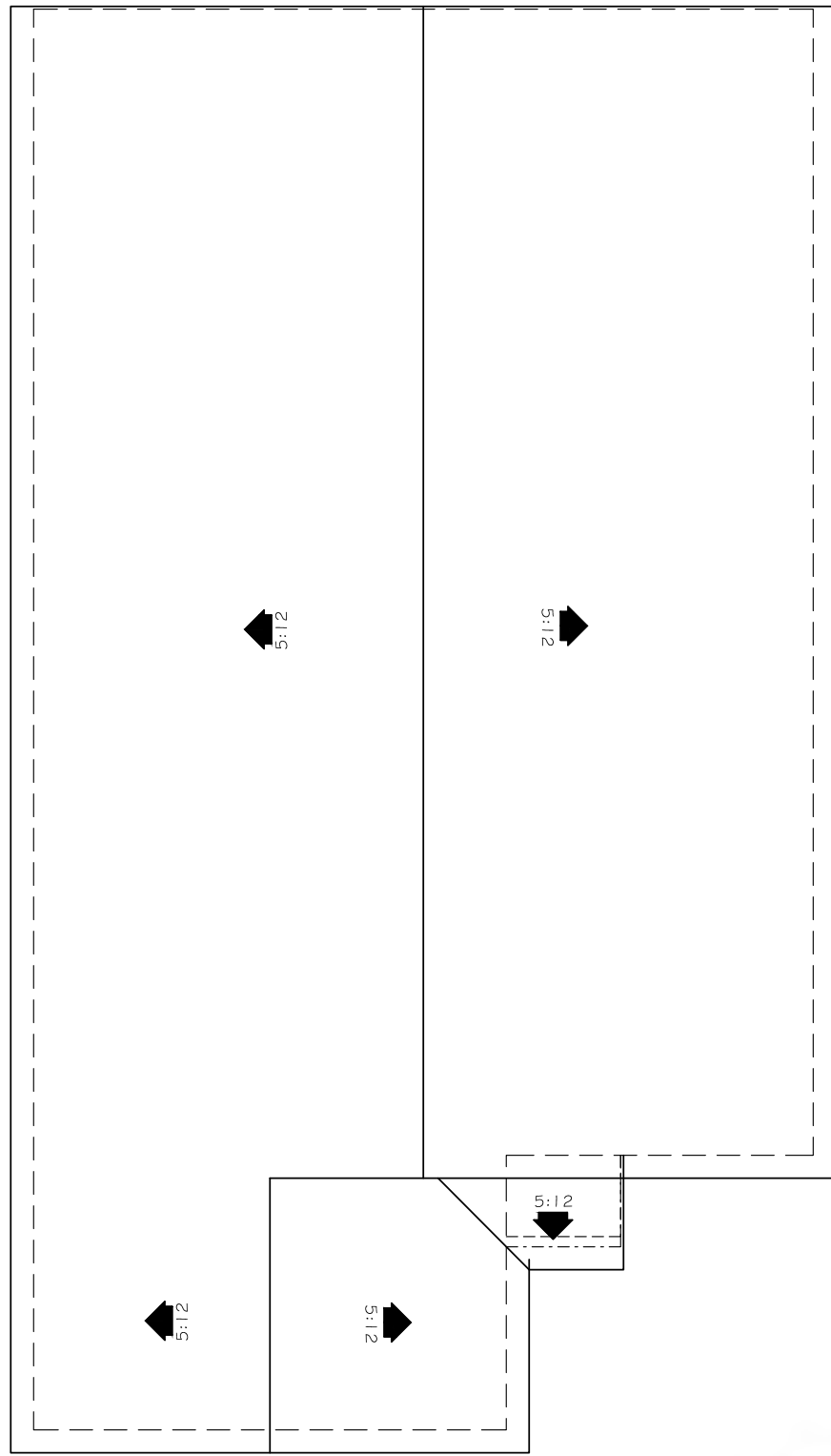

ROOF PLAN

SCALE 1/8" = 1'-0" (NOTE: SCALE 1/4" = 1'-0" ON 22x34 PAPER)



FRONT ELEVATION / 2778 ELEV "B"

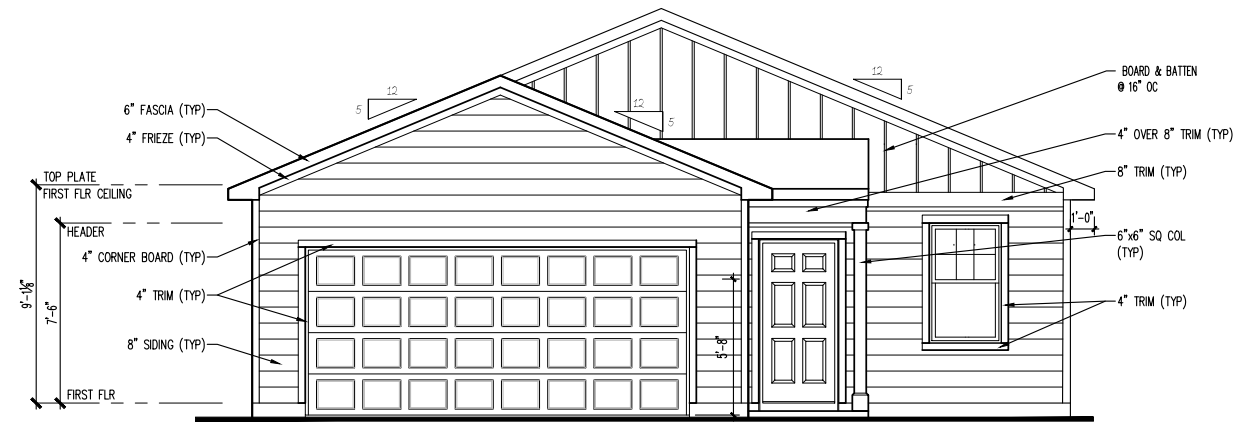

FRONT ELEVATION

SCALE 1/8" = 1'-0" (NOTE: SCALE 1/4" = 1'-0" ON 22x34 PAPER)

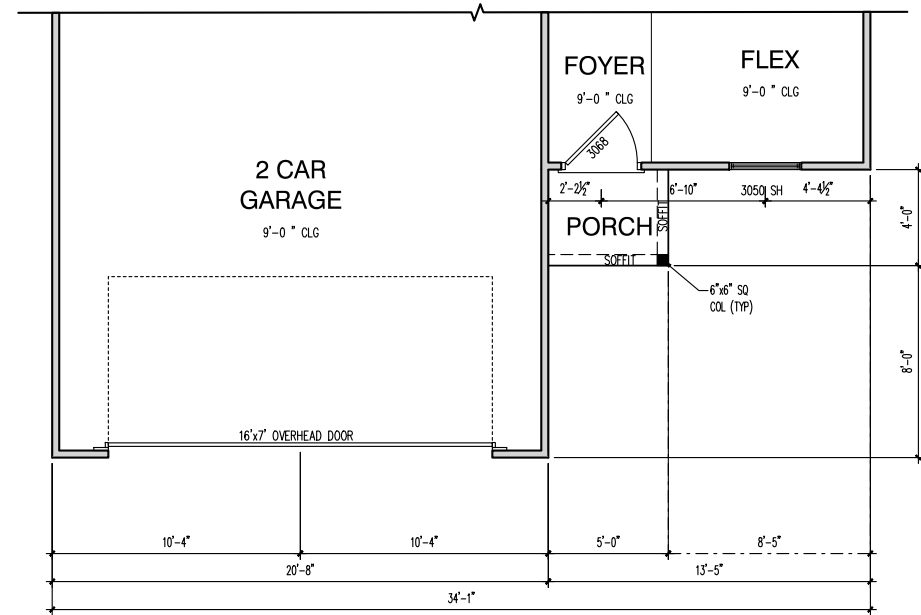

PARTIAL FIRST FLOOR PLAN

SCALE 1/8" = 1'-0" (NOTE: SCALE 1/4" = 1'-0" ON 22x34 PAPER)